

HM6116 Series — Maintenance Only

2048-word x 8-bit High Speed CMOS Static RAM

FEATURES

- Single 5V Supply
- High speed: Fast Access Time 120ns/150ns/200ns (max.)
- Low Power Standby and Low Power Operation
 - Standby: 100 μ W (typ.)
 - 10 μ W (typ.) (L-version)
 - Operation: 200mW (typ.)
 - 175mW (typ.) (L-version)
- Completely Static RAM: No clock or Timing Strobe Required
- Directly TTL Compatible: All Input and Output
- Pin Out Compatible with Standard 16K EPROM/MASK ROM
- Equal Access and Cycle Time
- Capability of Battery Back Up Operation (L-version)

ORDERING INFORMATION

Type No.	Access Time	Package
HM6116P-2	120ns	600mil 24pin Plastic DIP
HM6116P-3	150ns	
HM6116P-4	200ns	
HM6116LP-2	120 ns	
HM6116LP-3	150 ns	24pin Plastic SOP
HM6116LP-4	200 ns	
HM6116FP-2	120 ns	
HM6116FP-3	150 ns	
HM6114FP-4	200 ns	
HM6116LFP-2	120 ns	
HM6116LFP-3	150 ns	
HM6116LFP-4	200 ns	

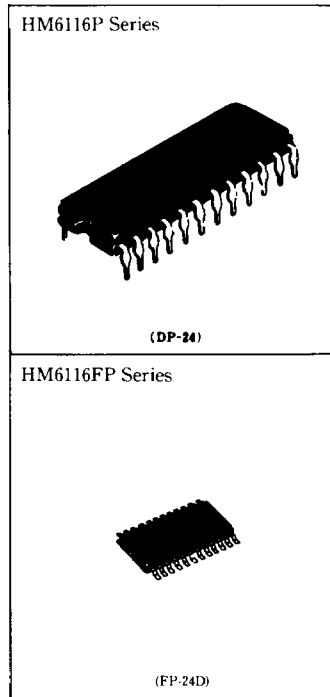

FUNCTIONAL BLOCK DIAGRAM

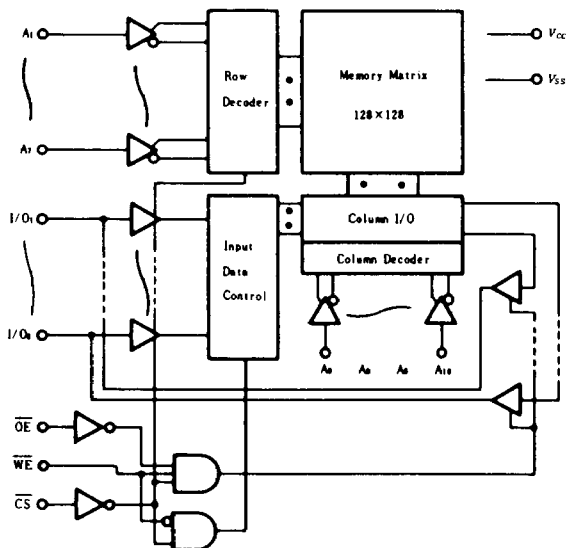

PIN ARRANGEMENT

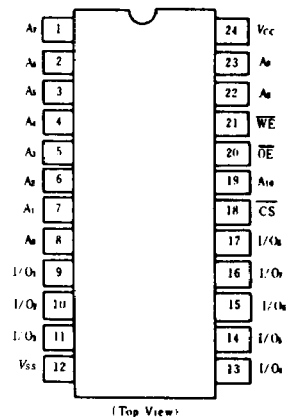

Note) This device is not available for new application.



■ ABSOLUTE MAXIMUM RATINGS

Item	Symbol	Rating	Unit
Voltage on Any Pin Relative to V_{SS}	V_T	-0.5*1 to +7.0	V
Operating Temperature	T_{op}	0 to +70	°C
Storage Temperature	T_{stg}	-55 to +125	°C
Storage Temperature Under Bias	T_{mb}	-10 to +85	°C
Power Dissipation	P_T	1.0	W

Note) *1. -3.5V for pulse width ≤ 50 ns

■ TRUTH TABLE

\overline{CS}	\overline{OE}	WE	Mode	V_{CC} Current	I/O Pin	Ref. Cycle
H	x	x	Not Selected	I_{SB}, I_{SB1}	High Z	
L	L	H	Read	I_{CC}	Dout	Read Cycle (1)~(3)
L	H	L	Write	I_{CC}	Din	Write Cycle (1)
L	L	L	Write	I_{CC}	Din	Write Cycle (2)

■ RECOMMENDED DC OPERATING CONDITIONS ($T_a=0$ to +70°C)

Item	Symbol	min	typ	max	Unit
Supply Voltage	V_{CC}	4.5	5.0	5.5	V
	V_{SS}	0	0	0	V
Input Voltage	V_{IH}	2.2	3.5	6.0	V
	V_{IL}	-0.3*1	—	0.8	V

Note) *1. -3.0V for pulse width ≤ 50 ns.

■ DC AND OPERATING CHARACTERISTICS ($V_{CC}=5V \pm 10\%$, $V_{SS}=0V$, $T_a=0$ to +70°C)

Item	Symbol	Test Conditions	HM6116-2			HM6116-3/4			Unit
			min	typ*1	max	min	typ*1	max	
Input Leakage Current	$ I_{LI} $	$V_{CC}=5.5V$, $V_{IN}=V_{SS}$ to V_{CC}	—	—	10	—	—	10	μA
			—	—	2*3	—	—	2*3	
Output Leakage Current	$ I_{LO} $	$\overline{CS}=V_{IH}$ or $\overline{OE}=V_{IN}$, $V_{I/O}=V_{SS}$ to V_{CC}	—	—	10	—	—	10	μA
			—	—	2*3	—	—	2*3	
Operating Power Supply Current	I_{CC}	$\overline{CS}=V_{IL}$, $I_{I/O}=0mA$	—	40	80	—	35	70	mA
			—	35*3	70*3	—	30*3	60*3	
Average Operating Current	I_{CC2}	Min. cycle, duty=100% $I_{I/O}=0mA$	—	40	80	—	35	70	mA
			—	35*3	70*3	—	30*3	60*3	
Standby Power Supply Current	I_{SB}	$\overline{CS}=V_{IH}$	—	5	15	—	5	15	mA
			—	4*3	12*3	—	4*3	12*3	
Output Voltage	V_{OL}	$\overline{CS} \geq V_{CC} - 0.2V$, $0V \leq V_{IN} \leq 0.2V$ or $V_{CC} - 0.2V \leq V_{IN}$	—	0.02	2	—	0.02	2	μA
			—	2*3	50*3	—	2*3	50*3	
Output Voltage	V_{OH}	$I_{OL}=4mA$	—	—	0.4	—	—	—	V
			—	—	—	—	—	0.4	V
			—	—	—	—	—	—	V
Output Voltage	V_{OH}	$I_{OH}=-1.0mA$	2.4	—	—	2.4	—	—	V

Notes) *1. $V_{CC}=5V$, $T_a=25^\circ C$

*2. Reference Only

*3. This characteristics are guaranteed only for L-version.



■ CAPACITANCE ($f=1\text{MHz}$, $T_a=25^\circ\text{C}$)

Item	Symbol	Test Conditions	typ	max	Unit
Input Capacitance	C_{in}	$V_{in}=0\text{V}$	3	5	pF
Input/Output Capacitance	C_{LO}	$V_{LO}=0\text{V}$	5	7	pF

Note) This parameter is sampled and not 100% tested.

■ AC CHARACTERISTICS ($V_{CC}=5\text{V}\pm 10\%$, $T_a=0$ to $+70^\circ\text{C}$)

● AC TEST CONDITIONS

- Input Pulse Levels: 0.8 to 2.4V
- Input Rise and Fall Times: 10 ns
- Input and Output Timing Reference Levels: 1.5V
- Output Load: 1TTL Gate and C_L (100pF) (including scope and jig)

● READ CYCLE

Item	Symbol	HM6116-2		HM6116-3		HM6116-4		Unit
		min	max	min	max	min	max	
Read Cycle Time	t_{RC}	120	—	150	—	200	—	ns
Address Access Time	t_{AA}	—	120	—	150	—	200	ns
Chip Select Access Time	t_{ACS}	—	120	—	150	—	200	ns
Chip Selection to Output in Low Z	t_{CLZ}	10	—	15	—	15	—	ns
Output Enable to Output Valid	t_{OE}	—	80	—	100	—	120	ns
Output Enable to Output in Low Z	t_{OLZ}	10	—	15	—	15	—	ns
Chip Deselection to Output in High Z	t_{CNZ}	0	40	0	50	0	60	ns
Chip Disable to Output in High Z	t_{ONZ}	0	40	0	50	0	60	ns
Output Hold from Address Change	t_{OH}	10	—	15	—	15	—	ns

● WRITE CYCLE

Item	Symbol	HM6116-2		HM6116-3		HM6116-4		Unit
		min	max	min	max	min	max	
Write Cycle Time	t_{WC}	120	—	150	—	200	—	ns
Chip Selection to End of Write	t_{CW}	70	—	90	—	120	—	ns
Address Valid to End of Write	t_{AW}	105	—	120	—	140	—	ns
Address Set Up Time	t_{AS}	20	—	20	—	20	—	ns
Write Pulse Width	t_{WP}	70	—	90	—	120	—	ns
Write Recovery Time	t_{WR}	5	—	10	—	10	—	ns
Output Disable to Output in High Z	t_{ONZ}	0	40	0	50	0	60	ns
Write to Output in High Z	t_{WNZ}	0	50	0	60	0	60	ns
Data to Write Time Overlap	t_{OW}	35	—	40	—	60	—	ns
Data Hold from Write Time	t_{DH}	5	—	10	—	10	—	ns
Output Active from End of Write	t_{OW}	5	—	10	—	10	—	ns

■ TIMING WAVEFORM

● READ CYCLE (1) ⁽¹⁾

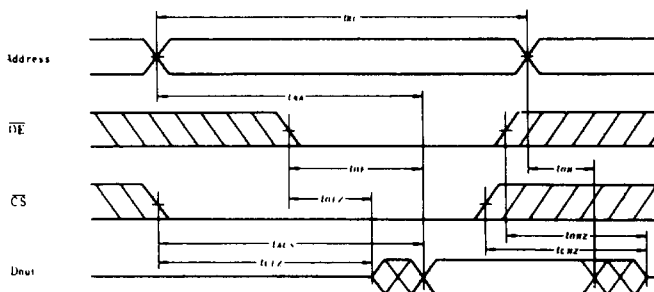

● READ CYCLE (2)⁽¹⁾⁽²⁾⁽⁴⁾

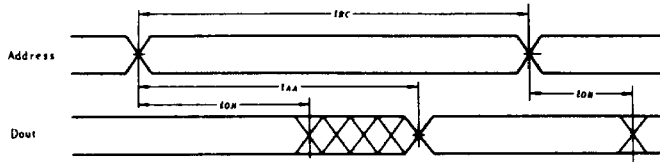

● READ CYCLE (3)⁽¹⁾⁽²⁾⁽⁴⁾

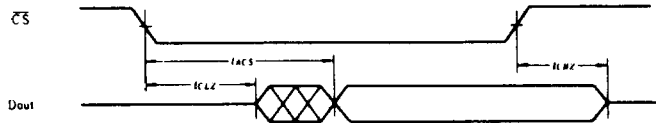

- NOTES:
1. WE is High for Read Cycle.
 2. Device is continuously selected, $\overline{CS} = V_{IL}$.
 3. Address Valid prior to or coincident with CS transition Low.
 4. $\overline{OE} = V_{IL}$.

● WRITE CYCLE (1)

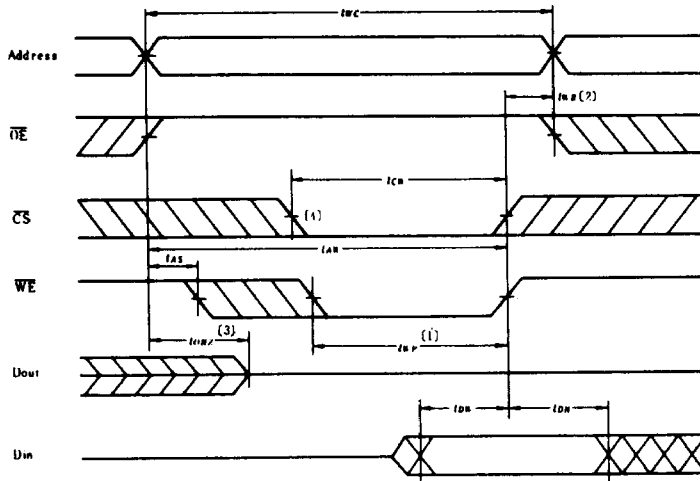

● WRITE CYCLE (2)⁽³⁾

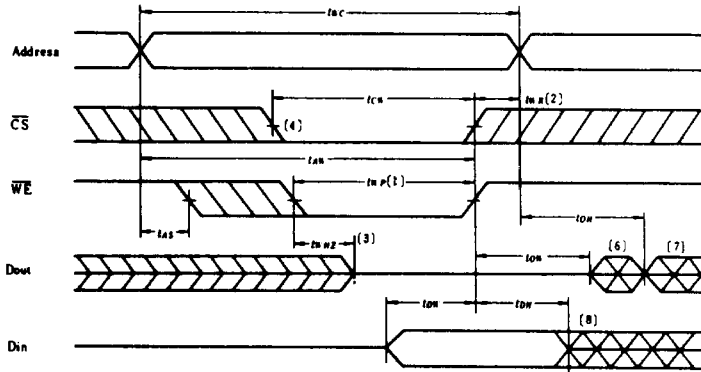

- NOTES:
1. A write occurs during the overlap (t_{WP}) of a low \overline{CS} and a low \overline{WE} .
 2. t_{WR} is measured from the earlier of \overline{CS} or \overline{WE} going high to the end of write cycle.
 3. During this period, I/O pins are in the output state so that the input signals of opposite phase to the outputs must not be applied.
 4. If the \overline{CS} low transition occurs simultaneously with the \overline{WE} low transitions or after the \overline{WE} transition, output remain in a high impedance state.
 5. \overline{OE} is continuously low. ($\overline{OE} = V_{IL}$)
 6. D_{out} is the same phase of write data of this write cycle.
 7. D_{out} is the read data of next address.
 8. If \overline{CS} is Low during this period, I/O pins are in the output state. Then the data input signals of opposite phase to the outputs must not be applied to them.

■ LOW V_{CC} DATA RETENTION CHARACTERISTICS ($T_a=0$ to $+70^\circ\text{C}$)

This characteristics are guaranteed only for L-version.

Item	Symbol	Test Conditions	min	typ	max	Unit
V_{CC} for Data Retention	V_{DR}	$\overline{CS} \geq V_{CC} - 0.2V$, $V_{in} \geq V_{CC} - 0.2V$ or $V_{in} \leq 0.2V$	2.0	—	—	V
Data Retention Current	I_{CCDR}^{*1}	$V_{CC}=3.0V, \overline{CS} \geq 2.8V, V_{IH} \geq 2.8V$ or $0V \leq V_{IN} \leq 0.2V$	—	—	30	μA
Chip Deselect to Data Retention Time	t_{CDR}	See Retention Waveform	0	—	—	ns
Operation Recovery Time	t_R		t_{RC}^{*2}	—	—	ns

Notes) *1. $10\mu\text{A}$ max at $T_a=0^\circ\text{C}$ to $+40^\circ\text{C}$, V_{IL} min = $-0.3V$
 *2. t_{RC} = Read Cycle Time.

● Low V_{CC} Data Retention Waveform

